

REVISIONS			
REV.	DESCRIPTION	DATE	APPROVED
A1	INITIAL DESIGN	7/29/2008	

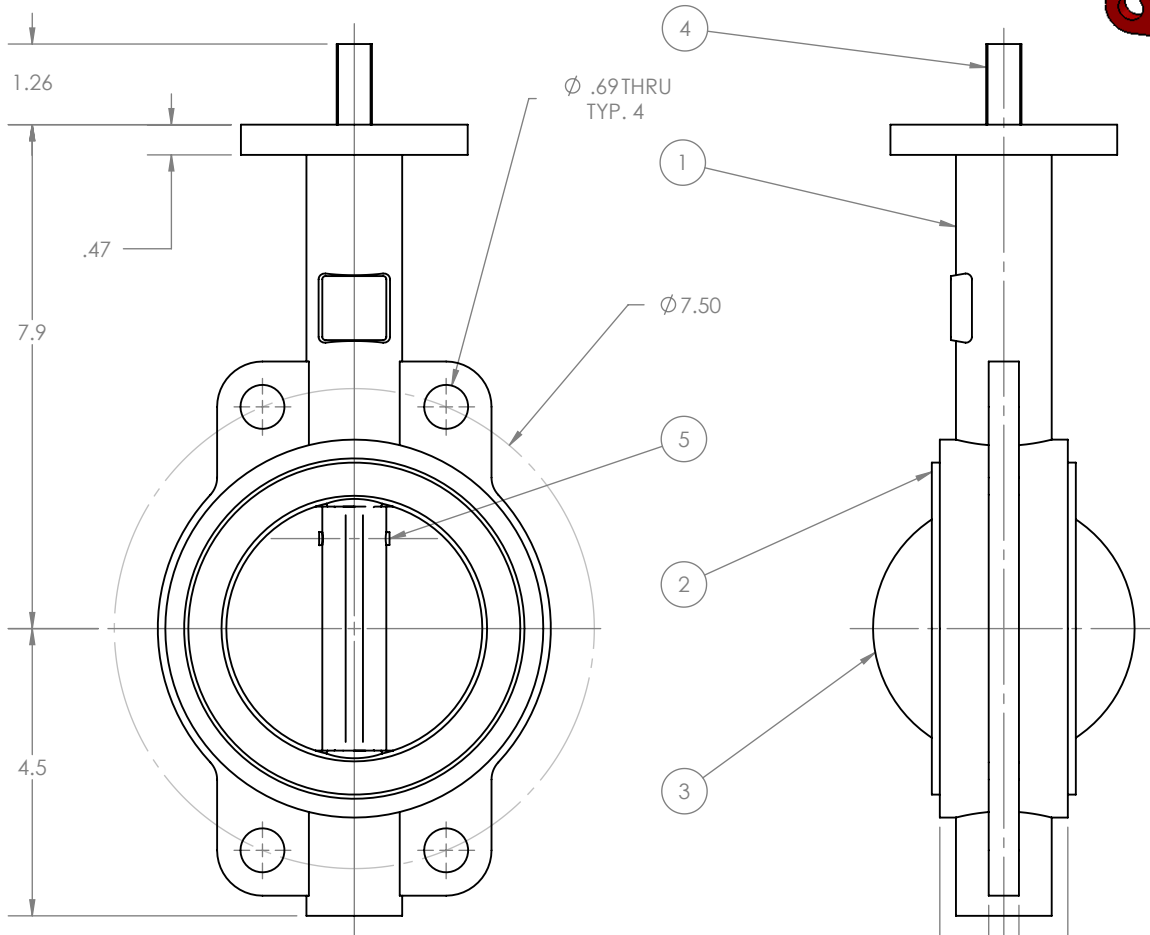

ITEM NO.	DESCRIPTION	MATERIAL	4" E8400/QTY.
1	E8400 BODY (4")	DUCTILE IRON	1
2	SEAT (4")	EPDM, BUNA, PTFE COATED EPDM, NEOPRENE, VITON	1
3	DISC (4")	316 STAINLESS STEEL	1
4	STEM (4")	316 STAINLESS STEEL	1
5	DISC PIN (4")	316 STAINLESS STEEL	1

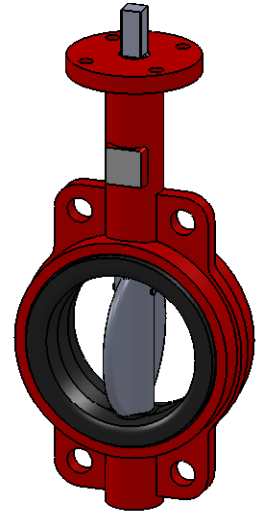
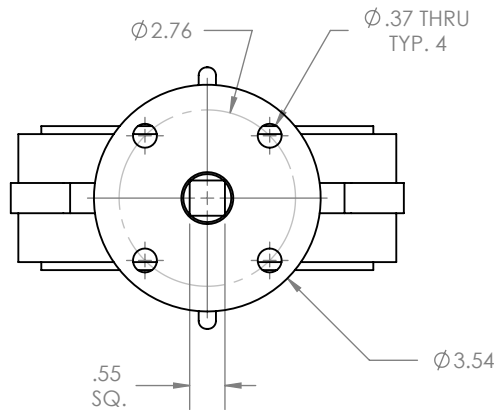

PROPRIETARY AND CONFIDENTIAL
 THE INFORMATION CONTAINED IN THIS DRAWING IS THE SOLE PROPERTY OF ELITE VALVE CANADA. ANY REPRODUCTION IN PART OR AS A WHOLE WITHOUT THE WRITTEN PERMISSION OF ELITE VALVE CANADA IS PROHIBITED.

	NAME	DATE
DRAWN	B. VOS	JUL 29/08
CHECKED		
ENG APPR.		
MFG APPR.		
Q.A.		

DESCRIPTION: 4" E8400 BUTTERFLY VALVE		DWG. NO. 60220416	
MATERIAL:	WEIGHT: #	SHEET 1 OF 1	SCALE:1:3
CUSTOMER:	SUPPLIER:	REV: A1	