

REVISIONS			
REV.	DESCRIPTION	DATE	APPROVED
A1	INITIAL DESIGN	7/18/2008	

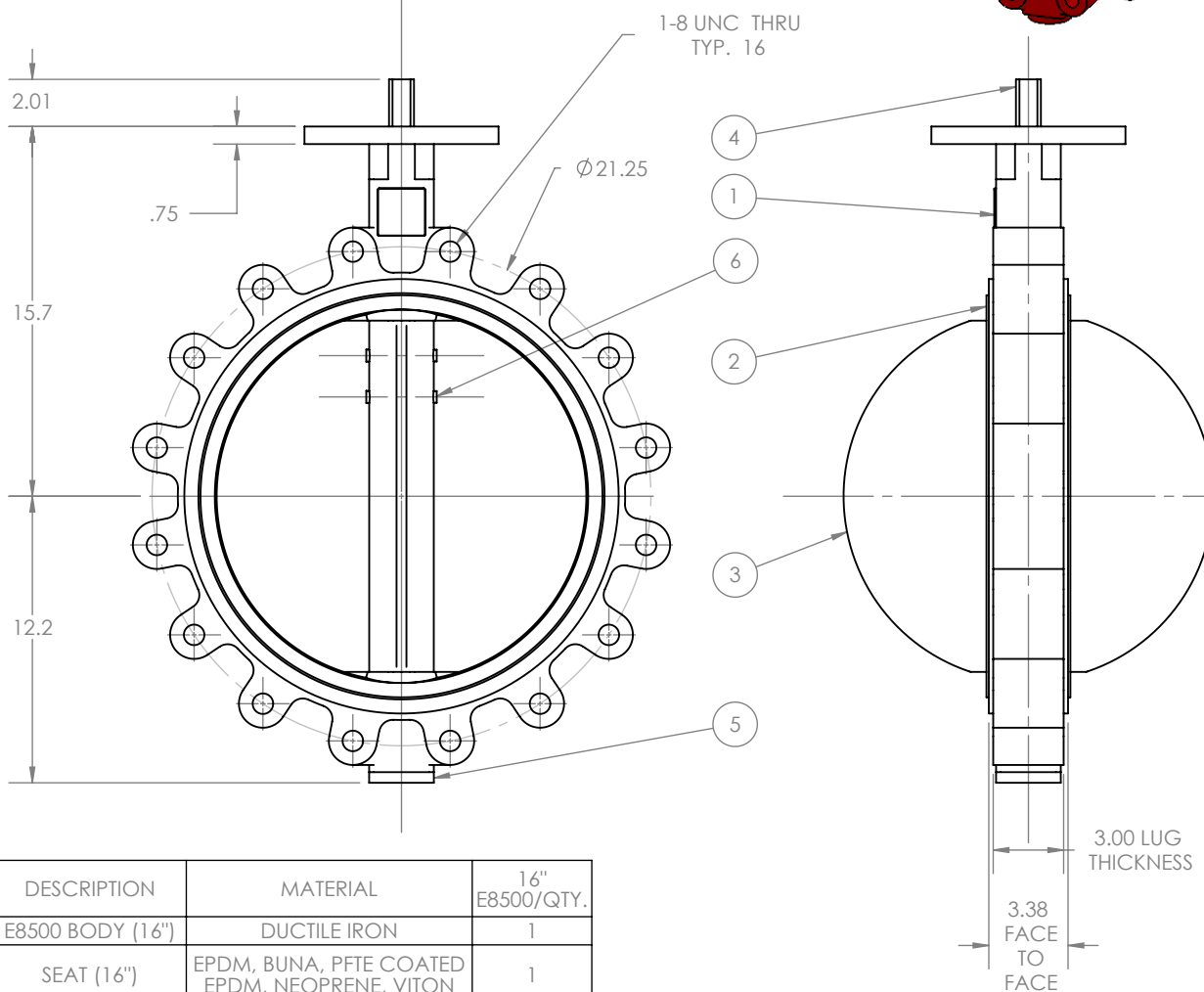

ITEM NO.	DESCRIPTION	MATERIAL	16" E8500/QTY.
1	E8500 BODY (16")	DUCTILE IRON	1
2	SEAT (16")	EPDM, BUNA, PTFE COATED EPDM, NEOPRENE, VITON	1
3	DISC (16")	316 STAINLESS STEEL	1
4	STEM (16")	316 STAINLESS STEEL	1
5	END CAP (16")	DUCTILE IRON	1
6	DISC PIN (16")	316 STAINLESS STEEL	2

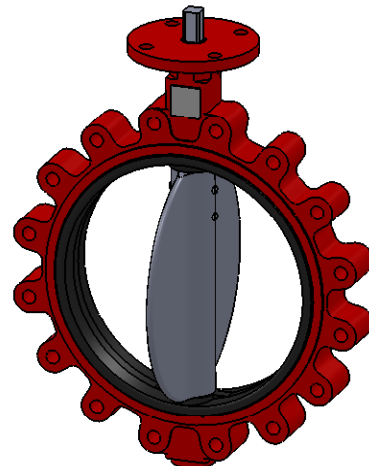
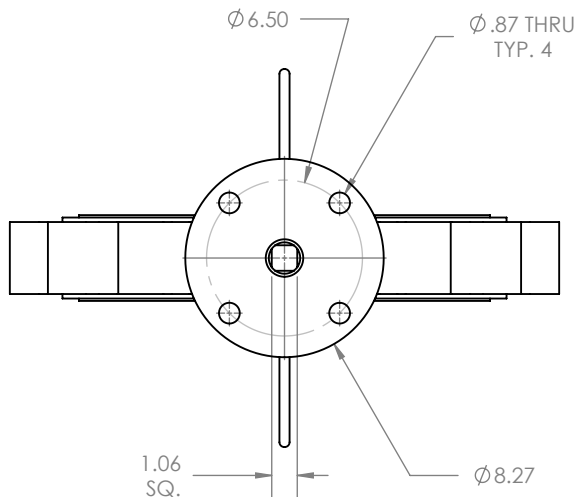

PROPRIETARY AND CONFIDENTIAL
 THE INFORMATION CONTAINED IN THIS DRAWING IS THE SOLE PROPERTY OF ELITE VALVE CANADA. ANY REPRODUCTION IN PART OR AS A WHOLE WITHOUT THE WRITTEN PERMISSION OF ELITE VALVE CANADA IS PROHIBITED.

	NAME	DATE
DRAWN	B. VOS	JUL 18/08
CHECKED		
ENG APPR.		
MFG APPR.		
Q.A.		

DESCRIPTION: 16" E8500 BUTTERFLY VALVE		DWG. NO. 60220396	
MATERIAL:	WEIGHT: #	SHEET 1 OF 1	SCALE:1:8
CUSTOMER:	SUPPLIER:	REV: A1	